

- 1
- 2
- 3
- 4
- 5
- 6
- 7
- 8
- 9
- 10
- 11
- 12
- 13
- 14
- 15
- 16
- 17
- 18

**CLAMP**

Glass-fibre reinforced polyamide based (PA) technopolymer, RAL 5005 blue colour, matte finish.

Produced from FDA compliant raw material (FDA CFR.21 and EU 10/2011).

**SCREW AND NUT (SUPPLIED)**

Cylindrical-head screws with hexagon socket in AISI 304 stainless steel with anti-seizure treatment.

Self-locking nut in AISI 304 stainless steel.

**FEATURES AND APPLICATIONS**

Clamps for tubes with a diameter of  $18 \pm 0.2$  and  $30 \pm 0.2$  mm.

For smaller diameter tubes, the hole reduction sleeve TCC-A can be used (ordered separately).

The "s" grub screw may be replaced by the kit TCC-KS.

The RAL 5005 blue colour is easily visible in case of accidental food contamination.

Particularly suitable for applications in the food and pharmaceutical industries.

**TECHNICAL DATA**

The resistance values shown in the table were measured during laboratory tests at ambient temperature with the screws tightened to the suggested torque "C#".

**ACCESSORIES ON REQUEST (TO BE ORDERED SEPARATELY)**

- TCC-A (see page -): reduction sleeves.
- TCC-KS (see page -): clamping kit.
- TCC-KV (see page -): screws and clamping nuts.
- GN 990 (see page -): connecting tubes.

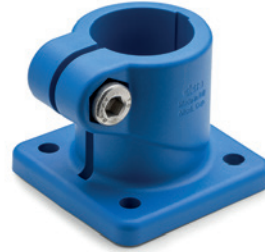

ELESA Original design

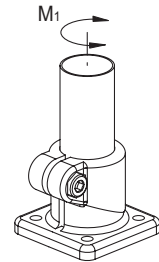
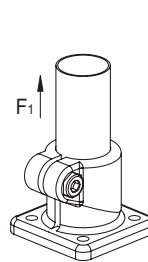
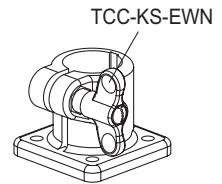
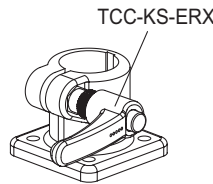
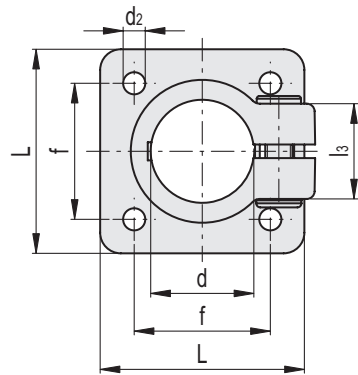
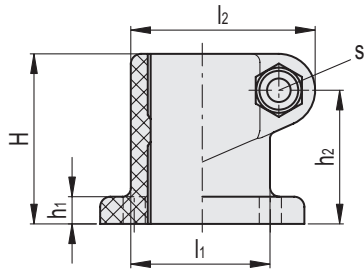

Conversion Table	
1 mm = 0.039 inch	
d	
mm	inch
18	0.70
30	1.17

Code	Description	d	L	H	d2	f ±0.2	h1	h2	l1	l2	l3	s	C# [Nm]	F1* [N]	M1** [Nm]	⚖️
191111	TCC-AB-18-VD	18	45	34	5.3	30	5	25	26	36.5	20	M6	5	1050	8	29
191211	TCC-AB-30-VD	30	60	50	6.5	40	8	40	42	53.5	27	M8	12	1650	33	75

# Suggested torque for screw assembly.

\* Resistance to tube pull out

\*\* Resistance to tube rotation