



















- 1 
- 2 
- 3 
- 4 
- 5 
- 6 
- 7 
- 8 
- 9 
- 10 
- 11 
- 12 
- 13 
- 14 
- 15 
- 16 
- 17 
- 18 
- 19 

MATERIAL

C10 zinc-plated steel.

RIVETS

Zinc-plated steel.

PULLING HOOK

Perpendicular to clamping arm, zinc-plated steel.

OSCILLATING PIN AND NUTS

Zinc-plated steel.

HANDLE

Polyurethane, red colour.

ANTI RELEASE LEVER

Zinc-plated steel.

LEVER ANTI-RELEASE COVERING

Polyvinylchloride (PVC).

SPRING

AISI 302 stainless steel.

FEATURES AND APPLICATIONS

Anti-release lever to prevent accidental opening in the presence of strong vibrations. All articulated joints are lubricated with special grease. MTD-S clamps ensure tight closing of any cover. The position of the pulling hook can be adjusted in length according to the specific applications.

ACCESSORIES ON REQUEST

TRU: U-shaped pulling hooks of various dimensions (see page).

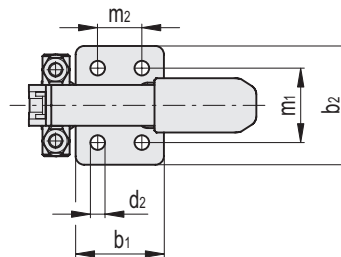
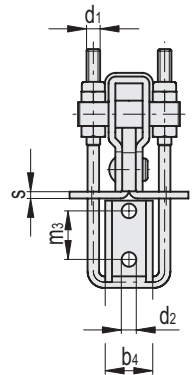
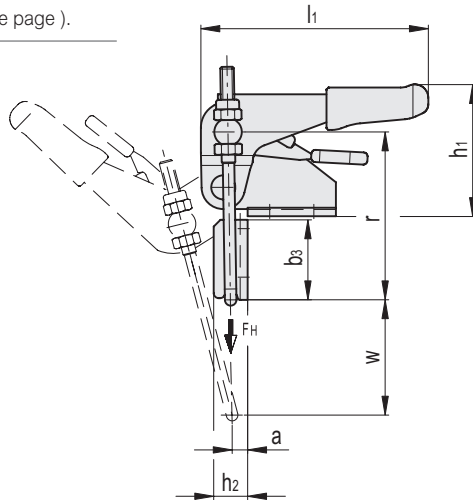
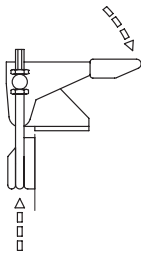

METRIC

Code	Description	a	b1	b2	b3	b4	d1	d2	h1	h2	l1	m1	m2	m3	r	s	w Stroke	FH* [N]	Δ
GG.AL636	MTD-S.160-T3L	5	26	35	25.5	14	M4	4.3	37	10	68	22	13	14.3	49.5+58	2	22+29	1600	113
GG.AL640	MTD-S.320-T3L	8	36	44	37	22	M6	6.5	53	15	106	25.5	19	20.5	75+95	3	39+49	3200	347
GG.AL644	MTD-S.700-T3L	13	52	54	48.5	26	M8	8.5	66	23	147	36.5	32	27	98+122	3.5	50+62	7500	759

* Holding force.